



***eureka***<sup>®</sup>

**BLAZE ORIGINAL™**  
INSTRUCTIONS MANUAL



## **Cautions for the first use**

Remember, safety should be your first priority.

1. Please make sure that you disconnect all other electronic devices connected to the power line you plan on using for your iron.
2. Make sure that you have removed any packaging or protective covers from the soleplate.
3. When plugged in for the first time, you may notice slight smoke due to production grease. Do not worry as this will cease shortly.
4. Always avoid harsh contact between your iron and other metal objects.

## Safety Instructions

1. Whenever you need to step away from the iron, make sure that you unplug it and leave the iron in a vertical position with soleplate facing upright.
2. Avoid children near the plugged iron.
3. Avoid contact of hot soleplate with your hands or flammable objects during use.
4. **CAUTION!** Make sure your iron is disconnected from the power supply before pouring water in the water tank.
5. **DO NOT** immerse any part of the iron in any type of liquid.
6. **DO NOT** use the iron if the cord is damaged. Consult with the manufacturer to get your iron fixed or replaced. (See last page for instructions)
7. To prevent deposition of minerals in the steam holes, it is recommended to use distilled water for cleaner steam holes.
8. Never use chemically descaled water.
9. Avoid directing steam towards people or animals. Steam is hazardous and can cause severe skin burns.

## Parts & Features

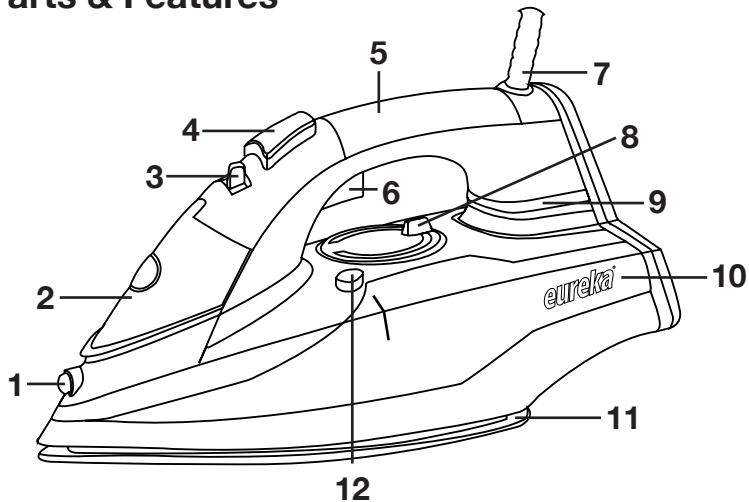

1. Spray Nozzle
2. Water Filling Cover
3. Steam Control
4. Spray Mister
5. Gripsoft™  
Rubberized Handle
6. Steam Surge™ Trigger

7. 10 Foot Electrical Cord with  
360° Pivot.
8. Heat Settings Dial
9. LED Indicator Light
10. Water Tank
11. Nano-Ceramic Shield™  
Coated Soleplate
12. Self-Cleaning Button

## Dry Ironing

1. Set the movable Steam Control Lever to point “**0**”.
2. Adjust ironing temperature in accordance with the fabric’s requirement.
3. The light “**ON**” indicates that the iron’s temperature is increasing steadily.  
Once desired temperature is reached, the light will turn “**OFF**” automatically.

## Filling with Water

Before filling the water tank, make sure that the iron is unplugged, temperature dial is positioned at the “**OFF**” mark, and the iron is held at approximately 45° tilt. Now, fill the water tank till the **MAX** mark.

## Water Mister

You can use the spraying option by repeatedly pressing the spray button. Make sure that your iron’s water tank is full.

## Steam Ironing

1. Fill the water tank in accordance with the instructions in the “Filling with Water” section.
2. Plug the cord into the outlet.

3. The light “**ON**” indicates that the iron’s temperature is increasing steadily.  
Once desired temperature is reached, the light will turn “**OFF**” automatically.
4. According to your requirement, adjust the Steam Adjustable Control Lever by turning right for more steam and left for less steam.
5. To achieve best steam discharge make sure that the thermostat dial is set at the MAX mark.

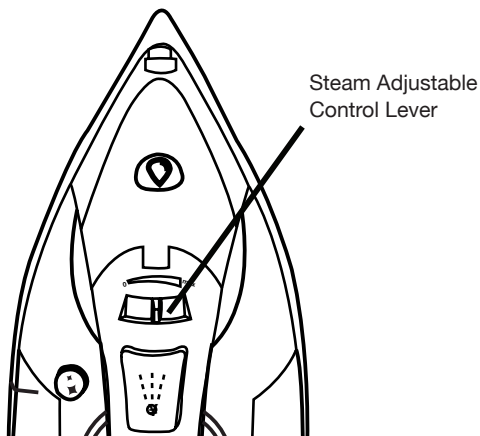

## Steam Surge™

This function is specially designed to remove the toughest wrinkles and creases present in heavy fabrics. By pressing the Steam Surge™ Trigger, a sudden surge of steam is expelled out of the soleplate, which is extremely useful in straightening even the most stubborn creases. For optimal results, make sure Steam Surge™ is used at higher temperatures and a regular 5 second delay between each steam burst is maintained. When steam is completely depleted, give it some time for steam to build up.

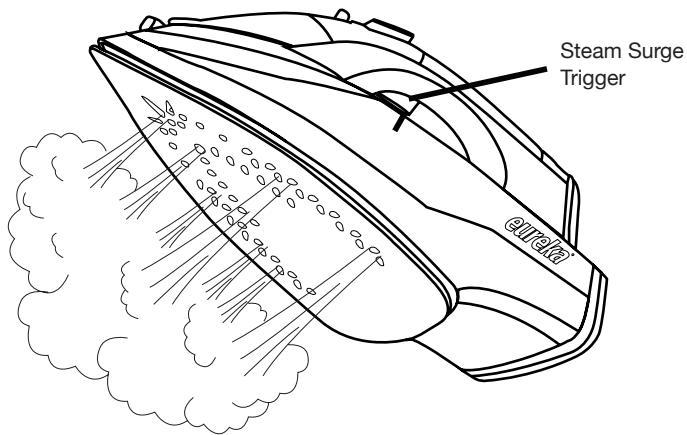



## **Vertical Steam**

By holding the iron in a vertical position, you can apply burst of steam to remove creases from curtains or any type of hanging fabrics.

## **Anti-Drip**

An advanced system inside your iron prevents water leakage at even the lowest heat setting.

## **Anti-Calc**

Over time, lime scales may accumulate inside the iron or on the soleplate's surface. To prevent this, an anti-calc filter is permanently installed in this appliance. It cannot be removed for cleaning purposes.

## Auto Shut-Off

1. If the iron is left unused for 15 minutes, the light will blink signaling that the iron has automatically shut off.
2. If the iron is left on the fabric or accidentally tips over, the iron will automatically shut off within 30 seconds. The blinking light on the iron will indicate that the iron has shut off.
3. Move the iron back and forth on the linen to auto-restart. The light will immediately stop blinking after achieving sufficient temperature for you to continue ironing.

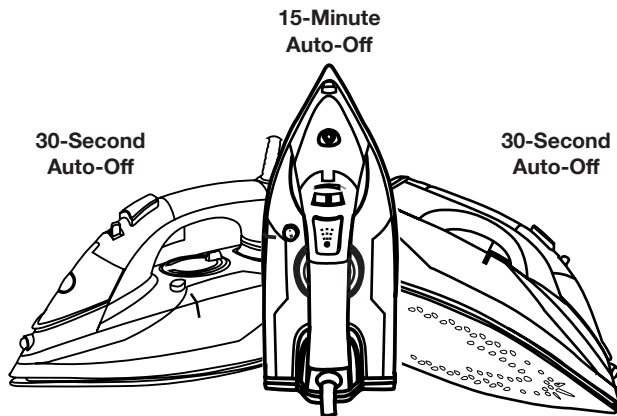

## Self- Cleaning

If the water in your area is hard (contains excessive dissolved mineral), self -cleaning should be done every two weeks.

1. Your iron should be unplugged before self-cleaning.
2. Using the Steam selector, set the steam level to mark “0”.
3. Fill the water tank to the **MAX** mark. Do not add any cleaning solutions Inside the water tank.
4. Before plugging in your iron make sure that the thermostat dial is set to **MAX**. Now allow the iron to heat up.
5. Indicator light will turn off once the iron reaches its optimal working temperature.
6. Once the indicator light goes off, turn the thermostat dial to **OFF** and disconnect the iron from the power line.
7. Firmly hold the iron over the sink and press/hold the self- cleaning button for several seconds.
8. Shake the iron back and forth while pressing the self-cleaning button. Steam and boiling water will expel along with impurities and other contaminants. (As shown on the following page)

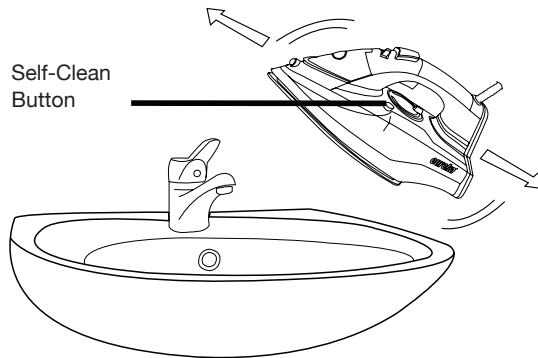

9. **CAUTION!** Avoid any contact with the iron during the cleaning process and firmly hold it above the sink to prevent any burns.
10. You can repeat the self-cleaning process if there are still some leftover impurities.
11. Dry up the soleplate by plugging the iron into the outlet. It will heat up the soleplate and evaporate water droplets.
12. Disconnect the iron from the power outlet once it reaches the required temperature. Then carefully remove any water stains with a piece of dry cloth.
13. Before storing, make sure the iron cools down completely.

# Heat Settings Dial

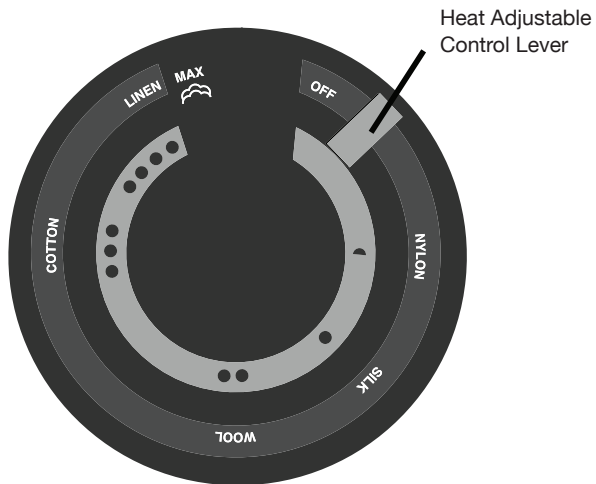

**Caution**



Please note that this symbol on your fabric's label means this article may not ironed.

## Cleaning & Maintenance

Before you begin cleaning, unplug the iron and allow it to cool down.

1. Clean the soleplate with any moist cloth and non-abrasive cleaner.
2. If fibers stick to the soleplate, use damp cloth immersed in vinegar to wipe off adherent fibers.
3. Never use strong acids or cleaning solutions when cleaning soleplate.
4. Remove any left over water from the water tank.
5. Make sure the steam selector is set to “**0**” and the thermostat dial is set to “**OFF**” before putting your iron away.

# Troubleshooting

<b>Problem</b>	<b>Possible Reasons</b>	<b>Solution</b>
There is little heat or no heat.	Cord may be unplugged or thermostat improperly set.	Cross check thermostat dial and look for any error in power transmission.
Steam has stopped or there is leakage.	Thermostat dial is set at the OFF mark.	Adjust thermostat dial to your desired setting.
There is no flow of steam or vertical steam is absent.	Repeated usage of vertical burst of steam or the iron is not hot enough.	Give regular pauses between each burst of steam.
Water is leaking from soleplate.	The iron is not hot enough.	Set the thermostat dial to a higher setting.
	The water is exceeding the MAX position mark.	Remove excess water.
There is less steam.	Clogged steam holes.	Use the iron's self-clean technology.
	Steam control lever is not set to the proper position.	By moving to the right, adjust the steam control lever to the proper position.
	Not enough water in tank.	Fill the water level up to the MAX mark on the tank.
No Water Spray	Lack of air pressure inside.	Press water spray button repeatedly until air pressure reaches the optimal level.
	Not enough water in the water tank.	Fill the water level up to the MAX mark on the tank.

# Warranty

This product has a warranty for 2 years from provable date of purchase against defects in material and workmanship. During this period such defects will be repaired, or the product will be replaced at no charge. This warranty does not cover damage caused by misuse, negligence, or improper installation. Warranty is also invalid in any case that the product is taken apart or serviced by an unauthorized service station.

## **TO CLAIM:**

Purchaser must receive a Return Authorization Number by calling our service center at 1-844-EUREKA5 (844-387-3525) or visit our website [www.eurekagarmentcare.net](http://www.eurekagarmentcare.net) for more info. Once your return has been authorized, please send your package, prepaid postage, with a copy of your proof of purchase. You will also need to enclose a letter explaining the nature of your difficulty in detail. Please allow 2-4 weeks for return shipping.

**Smartek USA Inc.**  
**12 Hinsdale Street, NY 11207**

Eureka is a registered trademark used under license from Electrolux Home Products Inc. Designed in USA.  
Assembled in China. © 2015



**MORE  
GREAT  
EUREKA  
PRODUCTS**

# *eureka*<sup>®</sup>



**HEAT RESISTANT  
3-FINGER GLOVE**  
(MODEL: ER1033)



**HEAT RESISTANT  
IRONING GLOVE**  
(MODEL: ER1035)



**PROTECTIVE  
IRON CASE**  
(MODEL: ER1050)



**EXTRA LARGE PROTECTIVE  
IRONING MESH**  
(MODEL: ER1020)



**SILICONE IRON  
REST PAD**  
(MODEL: ER1040)



**IRON & BOARD  
HOLDER**  
(MODEL: ER1010)

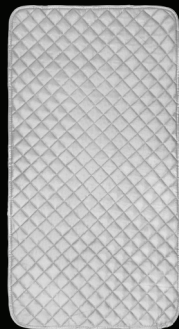

**SUPER MAGNETIC  
IRONING MAT**  
(MODEL: ER1025)

THANK YOU FOR PURCHASING *eureka* PRODUCTS

*eureka*<sup>®</sup>

FOR MORE INFO PLEASE VISIT: [WWW.EUREKAGARMENTCARE.NET](http://WWW.EUREKAGARMENTCARE.NET)