



# WH2200iXLT

Digital Inverter Generator

2200 Starting Watts | 1800 Running Watts

**California  
Proposition 65 Warning**

The engine exhaust from this product contains chemicals known to the state of California to cause cancer, birth defects or other reproductive harm.

**California  
Proposition 65 Warning**

Certain components in this product and its related accessories contain chemicals known to the state of California to cause cancer, birth defects or other reproductive harm. Wash hands after handling.

**DISCLAIMERS:**

All information, illustrations and specifications in this manual are based on the latest information available at the time of publishing. The illustrations used in this manual are intended as representative reference views only. Moreover, because of our continuous product improvement policy, we may modify information, illustrations and/or specifications to explain and/or exemplify a product, service or maintenance improvement. We reserve the right to make any change at any time without notice. Some images may vary depending upon which model is shown.

**ALL RIGHTS RESERVED:**

No part of this publication may be reproduced or used in any form by any means – graphic, electronic or mechanical, including photocopying, recording, taping or information storage and retrieval systems – without the written permission of MWE Investments, LLC.

# CONGRATULATIONS ON OWNING A WESTINGHOUSE INVERTER



This manual contains important instructions for operating this inverter. For your safety and the safety of others, be sure to read this manual thoroughly before operating the inverter. Failure to properly follow all instructions and precautions can cause you and others to be seriously hurt or killed.

## For Your Records:

Date of Purchase: \_\_\_\_\_ Inverter Model Number: \_\_\_\_\_

Purchased from Store/Dealer: \_\_\_\_\_ Inverter Serial Number: \_\_\_\_\_

**Purchase Receipt:** (retain your purchase receipt to ensure trouble-free warranty coverage)

## Product Registration

To ensure trouble-free warranty coverage, it is important you register your Westinghouse inverter. You can register your inverter by either:

1. Filling in the product registration form below and mailing to:

Product Registration  
MWE Investments, LLC  
777 Manor Park Drive  
Columbus, OH 43228

2. Registering your product online at [www.westinghouseportablepower.com/register-your-product/](http://www.westinghouseportablepower.com/register-your-product/)

To register your inverter you will need to locate the model number and serial number. The serial number tag is located toward the bottom of the inverter housing on the opposite side of the muffler.

---

## Product Registration Form

### PERSONAL INFORMATION

First Name: \_\_\_\_\_  
Last Name: \_\_\_\_\_  
Street Address: \_\_\_\_\_  
Street Address: \_\_\_\_\_  
City, State, ZIP: \_\_\_\_\_  
Country: \_\_\_\_\_  
Phone Number: \_\_\_\_\_  
E-Mail: \_\_\_\_\_

### INVERTER INFORMATION

Model Number: \_\_\_\_\_  
Serial Number: \_\_\_\_\_  
Date Purchased: \_\_\_\_\_  
Purchased From: \_\_\_\_\_

# TABLE OF CONTENTS

---

CONGRATULATIONS ON OWNING A WESTINGHOUSE INVERTER.....	3
For Your Records: .....	3
Product Registration .....	3
Product Registration Form.....	3
<b>SAFETY .....</b>	<b>5</b>
SAFETY DEFINITIONS .....	5
SAFETY SYMBOL DEFINITIONS .....	5
GENERAL SAFETY RULES .....	6
SAFETY LABELS AND DECALS .....	7
<b>UNPACKING .....</b>	<b>9</b>
UNPACKING THE INVERTER .....	9
Components: .....	9
<b>FEATURES .....</b>	<b>9</b>
GENERAL INVERTER FEATURES.....	9
CONTROL PANEL FEATURES .....	10
<b>OPERATION .....</b>	<b>11</b>
BEFORE STARTING THE INVERTER.....	11
INVERTER PARALLELING OPERATION .....	12
INITIAL OIL FILL .....	13
ADDING / CHECKING ENGINE FLUIDS AND FUEL.....	15
Checking and / or Adding Engine Oil.....	15
Adding Gasoline to the Fuel Tank.....	15
STARTING THE INVERTER .....	16
Using Efficiency Mode .....	17
Resetting the Reset Breaker .....	17
STOPPING THE INVERTER.....	18
Normal Operation .....	18
During an Emergency.....	18
<b>MAINTENANCE.....</b>	<b>19</b>
MAINTENANCE .....	19
Maintenance Schedule .....	19
ENGINE OIL MAINTENANCE .....	20
Engine Oil Specification.....	20
Checking Engine Oil .....	20
Adding Engine Oil .....	20
Changing Engine Oil.....	21
AIR FILTER MAINTENANCE.....	21
Cleaning the Air Filter .....	21
DRAINING THE FLOAT BOWL.....	22
SPARK PLUG MAINTENANCE .....	22
CLEANING THE SPARK ARRESTOR .....	24
CHECKING AND ADJUSTING VALVE LASH .....	25
CLEANING THE INVERTER.....	25
STORAGE.....	25
SERVICE PARTS.....	26
<b>TROUBLESHOOTING .....</b>	<b>28</b>
TROUBLESHOOTING .....	28

# SAFETY

## SAFETY DEFINITIONS

The words DANGER, WARNING, CAUTION and NOTICE are used throughout this manual to highlight important information. Be certain that the meanings of these alerts are known to all who work on or near the equipment.



**This safety alert symbol appears with most safety statements. It means attention, become alert, your safety is involved! Please read and abide by the message that follows the safety alert symbol.**



**DANGER**

Indicates a hazardous situation which, if not avoided, *will* result in death or serious injury.



**WARNING**

Indicates a hazardous situation which, if not avoided, *could* result in death or serious injury.



**CAUTION**

Indicates a hazardous situation which, if not avoided, *could* result in minor or moderate injury.

**NOTICE**

Indicates a situation which can cause damage to the inverter, personal property and/or the environment, or cause the equipment to operate improperly.

**NOTE:** Indicates a procedure, practice or condition that should be followed in order for the inverter to function in the manner intended.

## SAFETY SYMBOL DEFINITIONS

Symbol	Description
	Safety Alert Symbol
	Asphyxiation Hazard
	Burn Hazard
	Burst/Pressure Hazard
	Don't leave tools in the area
	Electrical Shock Hazard
	Explosion Hazard
	Fire Hazard
	Lifting Hazard
	Pinch-Point Hazard
	Read Manufacturer's Instructions
	Read Safety Messages Before Proceeding
	Wear Personal Protective Equipment (PPE)

# SAFETY

## GENERAL SAFETY RULES

### DANGER



Never use the inverter in a location that is wet or damp. Never expose the inverter to rain, snow, water spray or standing water while in use. Protect the inverter from all hazardous weather conditions. Moisture or ice can cause a short circuit or other malfunction in the electrical circuit.



Never operate the inverter in an enclosed area. Engine exhaust contains carbon monoxide. Only operate the inverter outside and away from windows, doors and vents.

### WARNING



Voltage produced by the inverter could result in death or serious injury.

- Never operate the inverter in rain or a floodplain unless proper precautions are taken to avoid being subject to rain or a flood.
- Never use worn or damaged extension cords.
- Always have a licensed electrician connect the inverter to the utility circuit.
- Never touch an operating inverter if the inverter is wet or if you have wet hands.
- Never operate the inverter in highly conductive areas such as around metal decking or steel works.
- Always use grounded extension cords. Always use three-wire or double-insulated power tools.
- Never touch live terminals or bare wires while the inverter is operating.
- Be sure the inverter is properly grounded before operating.

### NOTICE

Never modify the inverter.

Never operate the inverter if it vibrates at high levels, if engine speed changes greatly or if the engine misfires often.

Always disconnect tools or appliances from the inverter before starting.

### WARNING



Gasoline and gasoline vapors are extremely flammable and explosive under certain conditions.



- Always refuel the inverter outdoors, in a well-ventilated area.
- Never remove the fuel cap with the engine running.
- Never refuel the inverter while the engine is running. Always turn engine off and allow the inverter to cool before refueling.
- Only fill fuel tank with gasoline.
- Keep sparks, open flames or other form of ignition (such as match, cigarette, static electric source) away when refueling.
- Never overfill the fuel tank. Leave room for fuel to expand. Overfilling the fuel tank can result in a sudden overflow of gasoline and result in spilled gasoline coming in contact with HOT surfaces. Spilled fuel can ignite. If fuel is spilled on the inverter, wipe up any spills immediately. Dispose of rag properly. Allow area of spilled fuel to dry before operating the inverter.
- Wear eye protection while refueling.
- Never use gasoline as a cleaning agent.
- Store any containers containing gasoline in a well-ventilated area, away from any combustibles or source of ignition.
- Check for fuel leaks after refueling. Never operate the engine if a fuel leak is discovered.

### WARNING



Never operate the inverter if powered items overheat, electrical output drops, there is sparking, flames or smoke coming from the inverter, or if the receptacles are damaged.



Never use the inverter to power medical support equipment.



Always remove any tools or other service equipment used during maintenance from the inverter before operating.



# SAFETY

## SAFETY LABELS

The safety labels have specific placement and must be replaced if they are unreadable, damaged or missing.

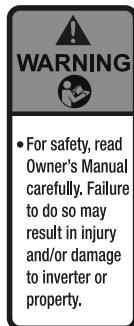
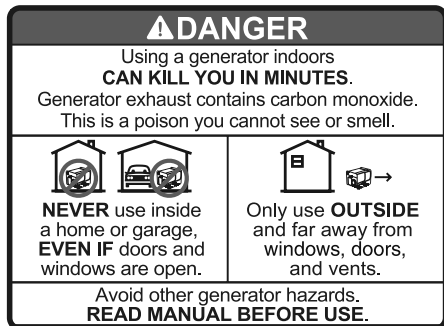

FRONT



BACK

Figure 3

# SAFETY



**1**

**For safety, carefully read the operation manual before operating this equipment:**

- Do not operate this equipment in poorly ventilated areas.
- Do not direct exhaust fumes toward people, buildings or equipment.
- When refueling, always stop the engine.
- Immediately wipe up any spilled fuel.
- Keep any flammable items away from this equipment.
- Use gasoline with a minimum octane rating of 87. Check and refill oil as required to ensure proper inverter performance.
- Do not expose inverter directly to rain or snow.
- Do not touch or contact outlets with wet hands.
- Do not connect the AC output to any indoor wiring.
- When operating your inverter, do not erect any barriers or obstacles around the equipment or inhibit air or exhaust flow.

**OIL**

**WH2200** Part No. 10200

Frequency 60Hz  
Voltage 120V  
Running Watts 1800  
Starting Watts 2200  
Current 15A

Oil Capacity WH2200  
4.2 QT  
13.5 OZ  
493 ML

SAE15W-40

Westinghouse

**2**

**NOTICE**

• Stop the engine before refueling and clean any spilled fuel.

• Use OEM spark plug only. Please refer to your Owner's Manual.

• Spark plug replacement chart:

AutoLite	4194	Torch	A5RTC
Denso	6070	NGK	CR4HSB

GAP .8 mm  
.03 in

**3**

**CAUTION**

Refer to the oil capacity table below to add the proper amount of oil to the engine before use.

• Do not overfill • Do not tip inverter when filling the oil

Capacity Chart:

2200  
400 ML  
13.5 OZ  
.42 QT



200 ML  
150 ML  
100 ML  
50 ML

Figure 4



# UNPACKING

## UNPACKING THE INVERTER

⚠ CAUTION	
	Always have assistance when lifting the inverter. The inverter is heavy; lifting it could cause bodily harm.
	Avoid cutting on or near staples to prevent personal injury.

**Tools required** – box cutter or similar device.

1. Carefully cut the packing tape on top of the carton.
2. Fold back top flaps to reveal the manual. Remove the document and save it for reference.
3. Carefully cut two sides of the carton to remove the inverter.

### Components:

- |                 |                              |
|-----------------|------------------------------|
| Tool Bag (1)    | Bottle of SAE 15W-40 Oil (1) |
| Screwdriver (1) | Oil Fill Bottle (1)          |

# FEATURES

## GENERAL INVERTER FEATURES



Figure 9

- 1 - Control Panel:** Contains the reset breaker, outlets and warning lights.
- 2 - 12-Volt DC Power Socket:** Provides 12-volt DC power up to 8 amps.
- 3 - Recoil Handle:** Pull to start the engine.
- 4 - Engine/Fuel Control Switch:** Turns the engine and the fuel on and off.
- 5 - Spark Plug Access Cover:** Remove the cover to service the spark plug.

- 6 - Engine Oil Fill/Drain Plug Service Panel:** Remove the panel to access the engine oil fill/drain plug for maintenance.
- 7 - Air Cleaner Access Panel:** Remove the panel to access the air cleaner for maintenance.
- 8 - Fuel Cap and Vent:** Open vent to run the engine, and close the vent when the engine is off.
- 9 - Muffler and Spark Arrestor:** Avoid contact until the engine is cooled down. The spark arrestor prevents sparks from exiting the muffler. It must be removed for servicing.

# FEATURES

## CONTROL PANEL FEATURES

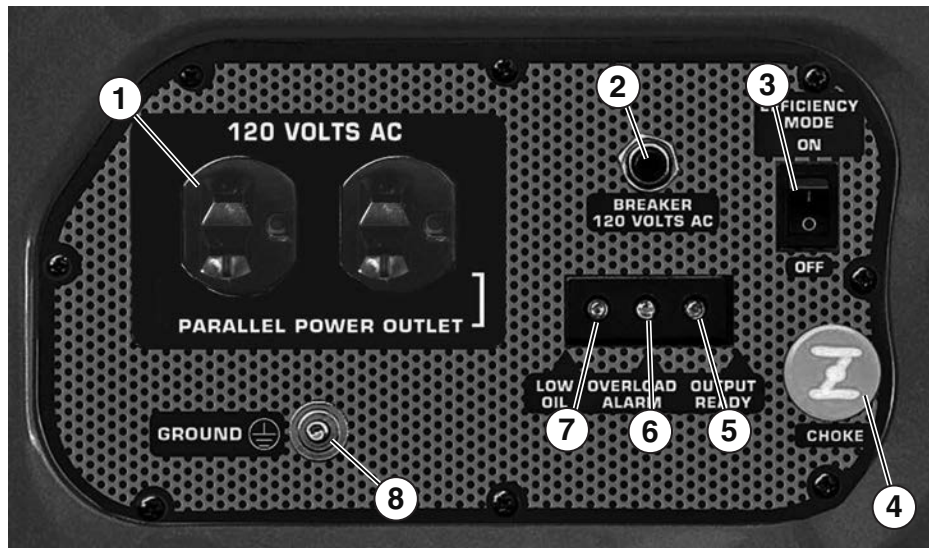

Figure 10 – Control Panel Features

- 1 - 120-Volt, 20-Amp Duplex Outlet (NEMA 5-20R):** The outlet is capable of carrying a maximum of 20 amps.
- 2 - Reset Breaker:** If the inverter is overloaded, the reset breaker will trip. The engine will continue to run, but there will be no output from the inverter. Unplug the devices and reduce the load. Push in the reset breaker to reset it.
- 3 - Efficiency Mode Switch:** When turned to the **ON** position, the engine will sense the load needed and run at a slower RPM to save fuel.
- 4 - Choke Knob:** Pull out to the **ON** position to start the engine, and push in to the **OFF** position once the engine is running.
- 5 - Output Ready LED:** The light will be green when the inverter is ready to be used.
- 6 - Overload LED:** The red light will come on if the inverter is overloaded. Decrease the load before restoring inverter operations.
- 7 - Low Oil LED:** The red light will come on and the engine will shut down if the oil level becomes low. You must add oil to the correct level before the inverter can be restarted.
- 8 - Ground Terminal:** The ground terminal is used to externally ground the inverter.

# OPERATION

## BEFORE STARTING THE INVERTER



**Before starting the inverter, review *Safety* section.**

**Location Selection** – Before starting the inverter, avoid exhaust and location hazards by verifying:

- You have selected a location to operate the inverter that is outdoors and well ventilated.
- You have selected a location with a level and solid surface on which to place the inverter.
- You have selected a location that is at least 6 feet (1.8 m) away from any building, other equipment or combustible material.
- If the inverter is located close to a building, make sure it is not located near any windows, doors and/or vents.

⚠ DANGER		⚠ PELIGRO	
USING A GENERATOR INDOORS CAN KILL YOU IN MINUTES. GENERATOR EXHAUST CONTAINS CARBON MONOXIDE. THIS IS A POISON YOU CANNOT SEE OR SMELL.		USAR EL GENERADOR EN INTERIORES LO PUEDE MATAR EN MINUTOS. EL ESCAPE DEL GENERADOR CONTIENE MONÓXIDO DE CARBONO. ESTE GAS ES UN VENENO QUE NO SE PUEDE VER NI OLER.	
NEVER USE INSIDE A HOME OR GARAGE, EVEN IF DOORS AND WINDOWS ARE OPEN.		ONLY USE OUTSIDE AND FAR AWAY FROM WINDOWS, DOORS, AND VENTS.	
		NUNCA USE EL GENERADOR DENTRO DEL HOGAR O EL GARAJE, AÚN SI LAS PUERTAS Y VENTANAS ESTÁN ABIERTAS. SOLO USELO EN EXTERIORES Y LEJOS DE VENTILACIONES, PUERTAS Y VENTANAS ABIERTAS.	

### ⚠ WARNING



**Always operate the inverter on a level surface. Placing the inverter on non-level surfaces can cause the inverter to tip over, causing fuel and oil to spill. Spilled fuel can ignite if it comes in contact with an ignition source such as a very hot surface.**

### NOTICE

Only operate the inverter on a solid, level surface. Operating the inverter on a surface with loose material such as sand or grass clippings can cause debris to be ingested by the inverter that could:

- Block cooling vents
- Block air intake system

**Weather** – Never operate your inverter outdoors during rain, snow or any combination of weather conditions that could lead to moisture collecting on, in or around the inverter.

**Dry Surface** – Always operate the inverter on a dry surface free of any moisture.

**No Connected Loads** – Make sure the inverter has no connected loads before starting it. To ensure there are no connected loads, unplug any electrical extension cords that are plugged into the control panel receptacles.

### NOTICE

Starting the inverter with loads already applied to it could result in damage to any appliance being powered off the inverter during the brief start-up period.

**Grounding the Inverter** – Consult with your local municipalities for your grounding codes.

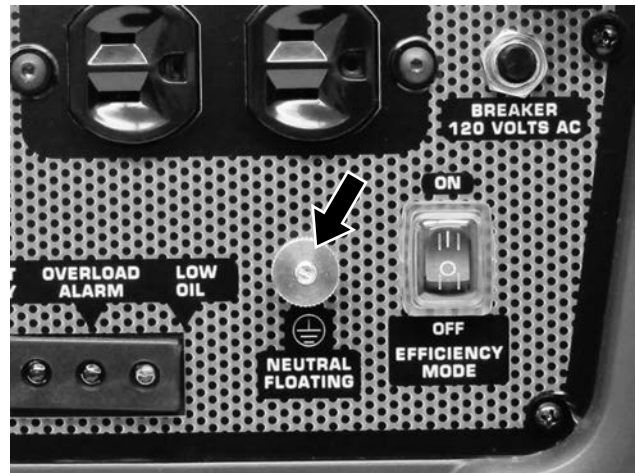

Figure 13 – Ground Terminal on the Control Panel

### ⚠ WARNING



**Be sure the inverter is properly connected to earth ground before operating.**

# OPERATION

**Using Extension Cords** – Westinghouse Portable Power assumes no responsibility for the content within this table. The use of this table is the responsibility of the user only. This table is intended for reference only. The results produced by using this table are not guaranteed to be correct or applicable in all situations as the type and construction of cords are highly variable. Always check with local regulations and a licensed electrician prior to installing or connecting an electrical appliance.

## Extension Cord Wire Gauge Size

AMPS	LENGTH OF EXTENSION CORD (ft)								
	10	20	30	40	50	60	80	100	120
5	20	18	16	14	12	12	10	10	8
10	18	16	14	12	12	10	10	8	8
15	16	14	12	12	10	10	8	8	6
20	14	12	12	10	10	8	8	6	6
25	12	12	10	10	8	8	6	6	6
30	12	10	10	8	8	6	6	6	6
35	10	10	8	8	6	6	6	6	6

## INVERTER PARALLELING OPERATION

**⚠ DANGER**

**⚡ Never connect the paralleling cord to the inverters with the inverters running. The inverters must not be running and both the paralleling cord switches must be off when connecting the cords.**

**⚠ WARNING**

**⚡ Do not attempt to parallel the Westinghouse inverter with any other manufacturers' inverters. Do not use the paralleling cord for any application other than inverter paralleling. Do not use this cord on other manufacturers' inverters.**

**⚠ WARNING**

**⚡ Always ensure that both ends of the paralleling cord are switched off before connecting the inverters.**

- Using only the Westinghouse paralleling cord (Part No. 260041) with both cord switches set to OFF (O), connect one male plug to one inverter and connect the remaining plug into the other inverter. Either of the receptacles on the inverters can be used (see Figure 15).



Figure 14 – Paralleling Cord ON/OFF Switches

# OPERATION

2. Start one of the inverters and wait until the ready light is on.
3. Turn both cord switches to ON (I).
4. Start the remaining inverter; wait until the ready light is on before connecting the load.
5. When power is present, a light will illuminate in the three-prong plug that is plugged into the inverter.



Figure 15 – Paralleling Cord Connected

6. To stop the inverters, unplug all connected loads, turn both cord switches to OFF (O) and unplug the cord on each inverter.
7. If during operation the inverters' output is stopped due to overloading, reduce the connected load by unplugging appliances, and then push the reset button and restart the inverter. When the ready light is on, the load can be reconnected.

## INITIAL OIL FILL

### NOTICE

Engine oil must be added when the inverter is on a flat, level surface, or an inaccurate reading may result. Do not overfill. If the engine is overfilled with oil, it can cause serious engine damage.

1. Loosen the screw and remove the engine oil fill/drain plug service panel to access the oil fill/drain plug (see Figure 21).



Figure 21 – Engine Service Panel

2. Clean the area around the oil fill/drain plug and remove plug (see Figure 22).



Figure 22 – Oil Fill/Drain Plug

**NOTE:** The oil capacity for the 2200iXLT is 400 ml.

# OPERATION

- Using the supplied oil fill container and oil, fill the container to the 2.0 mark on the container. Do not overfill (see Figure 23).

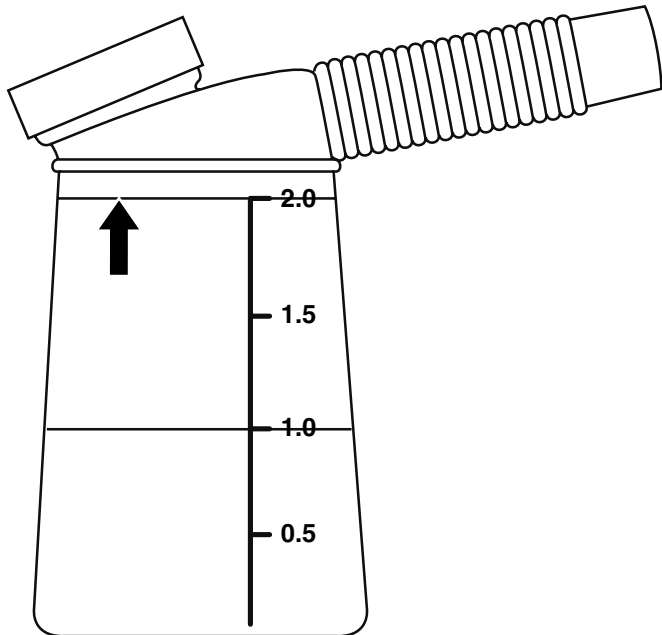

Figure 23 – Oil Fill Container

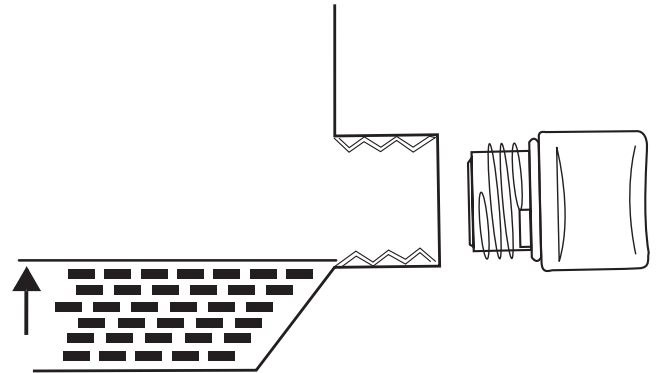

Figure 25 – Engine Oil Correct Level

- Do not overfill. If oil level is too high, oil will drain out through the fill plug.

## NOTICE

Do not tilt the inverter to add oil. It must be filled on a flat, level surface.

- Add the 200 ml of oil to the engine (see Figure 24).



Figure 24 – Adding Engine Oil

- Fill the container with oil again to the 2.0 mark.
- Add the 200 ml of oil to the engine. The oil should now be at the correct level (see Figure 25).



# OPERATION

## ADDING / CHECKING ENGINE FLUIDS AND FUEL



Before adding/checking engine fluids and fuel, review *Safety section*.

### DANGER



Filling the fuel tank with gasoline while the inverter is running can cause gasoline to leak and come in contact with hot surfaces that can ignite the gasoline.

Before starting the inverter, always check the level of:

- Engine oil
- Gasoline in the fuel tank

Once the inverter is started and the engine gets warm, it is not safe to add gasoline to the fuel tank or engine oil to the engine while the engine is running or the engine and muffler are hot.

## Checking and / or Adding Engine Oil

### WARNING



Internal pressure can build in the engine crankcase while the engine is running. Removing the oil fill plug/dipstick while the engine is hot can cause extremely hot oil to spray out of the crankcase and can severely burn skin. Allow engine oil to cool for several minutes before removing the oil fill plug/dipstick.

The unit as shipped does not contain oil in the engine. You must add engine oil before starting the inverter for the first time. See *Engine Oil Maintenance* for instructions on checking engine oil level and the procedure for adding engine oil.

### NOTICE

The inverter does not contain engine oil as shipped. Attempting to start the engine without adding engine oil will permanently damage internal engine components.

## Adding Gasoline to the Fuel Tank

### WARNING



Never refuel the inverter while the engine is running.



Always turn the engine off and allow the inverter to cool before refueling.

**Required Gasoline** – Only use gasoline that meets the following requirements:

- Unleaded gasoline only
- Gasoline with maximum 10% ethanol added
- Gasoline with an 87 octane rating or higher

**Filling the Fuel Tank** – Follow the steps below to fill the fuel tank:

1. Shut off the inverter.
2. Allow the inverter to cool down so all surface areas of the muffler and engine are cool to the touch.
3. Move the inverter to a flat surface.
4. Clean area around the fuel cap.
5. Remove the fuel cap by rotating counterclockwise.

### NOTICE

Do not overfill the fuel tank. Spilled fuel will damage some plastic parts.

6. Slowly add gasoline into the fuel tank. Be very careful not to overfill the tank. The gasoline level should NOT be higher than the red ring (see *Figure 26*).
7. Install the fuel cap by rotating clockwise.



Figure 26 – Maximum Gasoline Fill Level

# OPERATION

## ⚠ CAUTION



**Avoid prolonged skin contact with gasoline. Avoid prolonged breathing of gasoline vapors.**

## STARTING THE INVERTER

For proper starting and operation of the inverter, make sure you review the inverter features and their descriptions.



**Before starting the inverter, review Safety Section.**

Before attempting to start the inverter, verify the following:

- The inverter is situated in a proper location (see *Location Selection*).
- The inverter is on a dry surface (see *Weather and Dry Surface*).
- All loads are disconnected from the inverter (see *No Connected Loads*).
- The inverter is properly grounded (see *Grounding the Inverter*).

## ⚠ DANGER



**Never use the inverter in a location that is wet or damp. Never expose the inverter to rain, snow, water spray or standing water while in use. Protect the inverter from all hazardous weather conditions. Moisture or ice can cause a short circuit or other malfunction in the electrical circuit.**



**Never operate the inverter in an enclosed area. Engine exhaust contains carbon monoxide. Only operate the inverter outside and away from windows, doors and vents.**

## NOTICE

The engine is equipped with a low oil shutdown switch. If the oil level becomes low, the engine will shut down and will not start until the oil is filled to the proper level.

Be sure the engine has the proper oil level before using. Failure to verify that the engine has the proper oil level could result in engine damage.

Disconnect all loads from the inverter before starting. Failure to verify all loads are disconnected prior to starting the inverter could result in damage to the connected appliances.

**NOTE: There are key areas that need to be addressed when starting the inverter. These key areas are highlighted in yellow.**

1. Turn the fuel tank vent to the **ON** position (see *Figure 27*).



*Figure 27 – Fuel Tank Vent*

2. Turn the engine/fuel control switch to the **ON** position (see *Figure 28*).

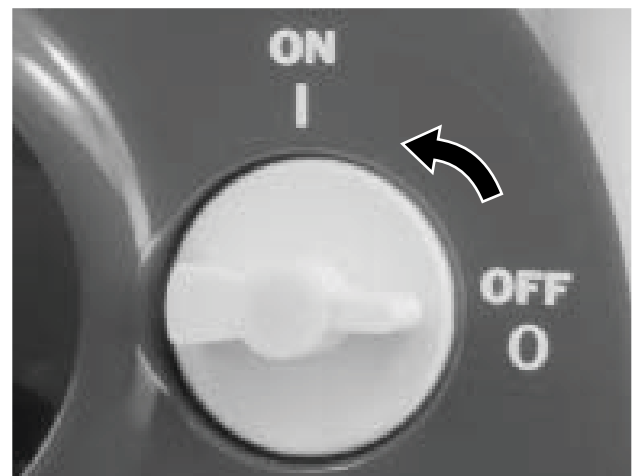

*Figure 28 – Engine/Fuel Control Switch*

# OPERATION

3. Pull the choke knob out to the **ON** position (see Figure 29).



Figure 29 – Choke Knob

4. Firmly grasp and pull the recoil handle slowly until you feel increased resistance. At this point, apply a rapid pull while pulling out from the inverter (see Figure 30).

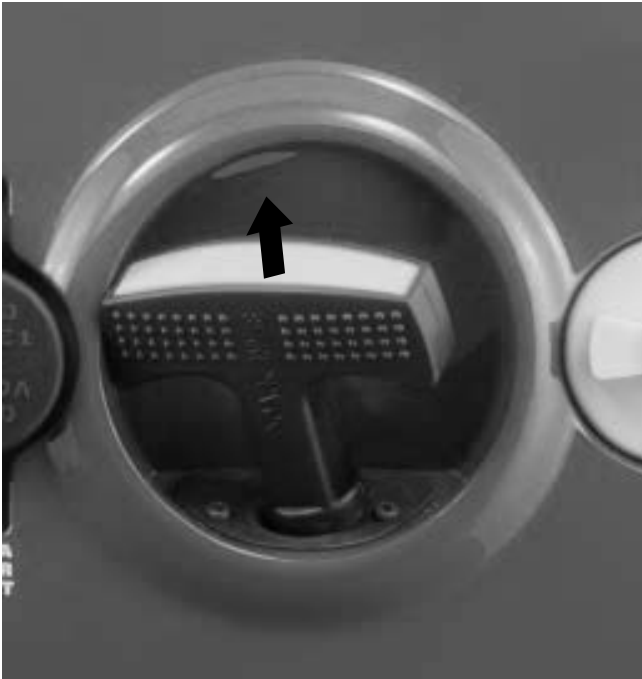

Figure 30 – Recoil Handle

5. As the engine starts and stabilizes, gradually push the choke knob back in to the **OFF** position.

## Using Efficiency Mode

The inverter is equipped with an efficiency mode switch to minimize fuel consumption. In efficiency mode, the inverter will sense the load and adjust the engine RPM to the current load requirements. Efficiency mode should be used only after the inverter has been warmed up to operating temperature.

1. To turn on the efficiency mode, press the switch to the **ON** position (see Figure 31).

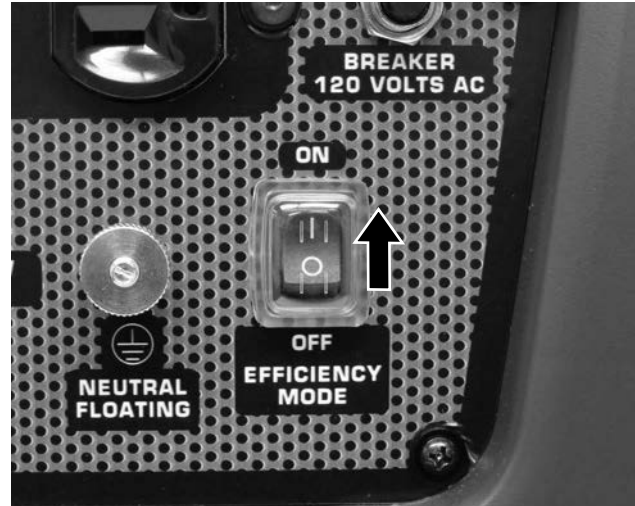

Figure 31 – Efficiency Mode Switch

2. If no load is present, the inverter RPM will drop down to an idle speed.
3. As a load is applied, the inverter will sense the load and engine RPM will increase according to the load applied.
4. To run the inverter at maximum power and RPM, press the efficiency mode switch to the **OFF** position.

## Resetting the Reset Breaker

The inverter will trip the breaker and automatically disconnect from the load when the controls sense a predetermined overload condition. The inverter engine will continue to run, but there will not be any electrical output.

1. Turn off all devices and unplug them from the inverter.
2. Determine the wattage required from the devices being powered by the inverter. Make sure the wattage required does not exceed the maximum output of the inverter.
3. Press in the reset breaker to reset it.
4. Plug the devices in to the inverter.
5. Turn on the devices as needed.

# OPERATION

---

## STOPPING THE INVERTER

### Normal Operation

During normal operation, use the following steps to stop your inverter:

1. Remove any connected loads from the control panel receptacles.
2. Allow the inverter to run at “no load” to reduce and stabilize engine and alternator temperatures.
3. Move the engine control switch to the **OFF** position.
4. Turn the fuel tank vent to the **OFF** position.

### During an Emergency

If there is an emergency and the inverter must be stopped quickly, move the engine control switch to the **OFF** position immediately.

# MAINTENANCE

## MAINTENANCE



Before performing maintenance on the inverter, review *Safety section* and the following safety messages.

### WARNING



Avoid accidentally starting the inverter during maintenance by removing the spark plug boot from the spark plug. For electric start inverters, also disconnect the battery wires from the battery (disconnect the black negative (-) wire first) and place the wires away from the battery posts to avoid arcing.



Allow hot components to cool to the touch prior to performing any maintenance procedure.



Internal pressure can build in the engine crankcase while the engine is running. Removing the oil fill plug/dipstick while the engine is hot can cause extremely hot oil to spray out of the crankcase and can severely burn skin. Allow engine oil to cool for several minutes before removing the oil fill plug/dipstick.



Always perform maintenance in a well-ventilated area. Gasoline fuel and fuel vapors are extremely flammable and can ignite under certain conditions.

### CAUTION



Avoid skin contact with engine oil or gasoline. Prolonged skin contact with engine oil or gasoline can be harmful. Frequent and prolonged contact with engine oil may cause skin cancer. Take protective measures and wear protective clothing and equipment. Wash all exposed skin with soap and water.

## Maintenance Schedule

### WARNING



Failure to perform periodic maintenance or not following maintenance procedures can cause the inverter to malfunction and could result in death or serious injury.

### NOTICE

Periodic maintenance intervals vary depending on inverter operating conditions. Operating the inverter under severe conditions, such as sustained high-load, high-temperature, or unusually wet or dusty environments, will require more frequent periodic maintenance. The intervals listed in the maintenance schedule should be treated only as a general guideline.

Following the maintenance schedule is important to keep the inverter in good operating condition. The following is a summary of maintenance items by periodic maintenance intervals.

Table 1: Maintenance Schedule - Owner Performed

Maintenance Item	Before Every Use	After First 20 Hours or First Month of Use	After 50 Hours of Use or Every 3 Months	After 100 Hours of Use or Every 6 Months	After 300 Hours of Use or Every Year
Engine Oil	Check Level	Change	Change	–	–
Cooling Features	Check/Clean	–	–	–	–
Air Filter	Check	–	Clean <sup>1</sup>	–	Replace
Spark Plug	–	–	–	Check/Clean	Replace
Spark Arrestor	–	–	–	Check/Clean	–

<sup>1</sup> Service more frequently if operating in dry and dusty conditions.



# ENGINE OIL MAINTENANCE

## Engine Oil Specification

1. Only use the engine oil specified in *Figure 32*.
2. Only use 4-stroke/cycle engine oil. NEVER USE 2-STROKE/CYCLE OIL. Synthetic oil is an acceptable substitute for conventional oil.

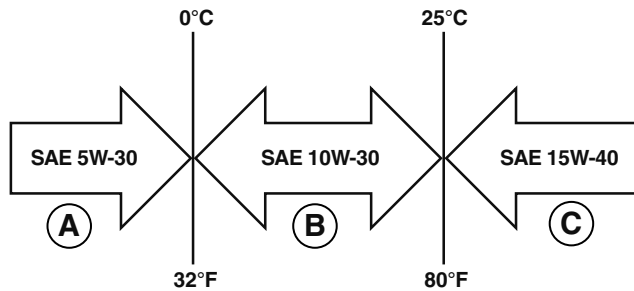

Figure 32 – Recommended Oil

## Checking Engine Oil

### NOTICE

Always maintain proper engine oil level. Failure to maintain proper engine oil level could result in severe damage to the engine and/or shorten the life of the engine.

Always use the specified engine oil. Failure to use the specified engine oil can cause accelerated wear and/or shorten the life of the engine.

Engine oil level should be checked before every use.

1. Always operate or maintain the inverter on a flat surface.
2. Stop engine if running.
3. Let engine sit and cool for several minutes (allow crankcase pressure to equalize).
4. Remove the engine service panel to access the oil fill/drain plug.
5. With a damp rag, clean around the oil fill/drain plug.
6. Remove the oil fill/drain plug (*see Figure 35*).

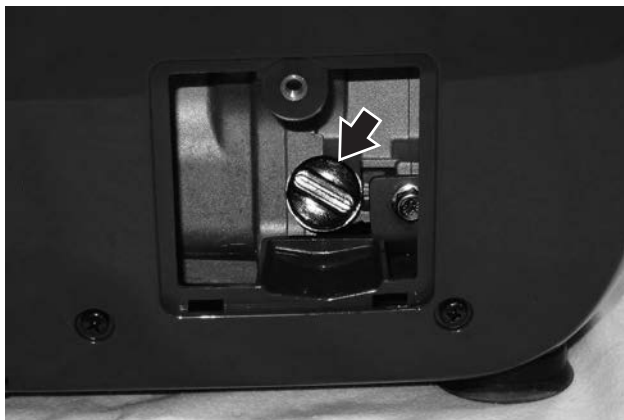

Figure 35 – Oil Fill/Drain Plug

### NOTICE

Engine oil must always be checked and added when the inverter is on a flat, level surface, or an inaccurate reading may result, causing serious engine damage.

7. Check oil level:  
When checking the engine oil, remove the oil fill/drain plug.
  - The oil level is acceptable if oil is visible at the bottom of the threads of the oil fill plug.
  - If oil level is low, add to the correct level using the supplied oil fill bottle. Do not overfill the oil crankcase.

## Adding Engine Oil

1. Always operate or maintain the inverter on a flat surface.
2. Stop engine if running.
3. Let engine sit and cool for several minutes (allow crankcase pressure to equalize).
4. Remove the engine service panel to gain access to the oil fill/drain plug.
5. Thoroughly clean around the oil fill/drain plug.
6. Remove the oil fill/drain plug.
7. Select the proper engine oil as specified in *Figure 32*.
8. Using the supplied oil fill container, slowly add engine oil to the engine. Stop frequently to check the oil level and avoid overfilling (*see Figure 38*).



Figure 38 – Adding Engine Oil

9. Continue to add oil until the oil is at the correct level. *See Checking Engine Oil*



# MAINTENANCE

## Changing Engine Oil

1. Stop the engine.
2. Let engine sit and cool for several minutes (allow crankcase pressure to equalize).
3. Remove the engine service panel to gain access to the oil fill/drain plug.
4. Place oil pan (or suitable container) under the oil fill/drain plug.
5. With a damp rag, thoroughly clean around the oil fill/drain plug.
6. Tilt the inverter so the oil drains down the trough into the container (see Figure 40).

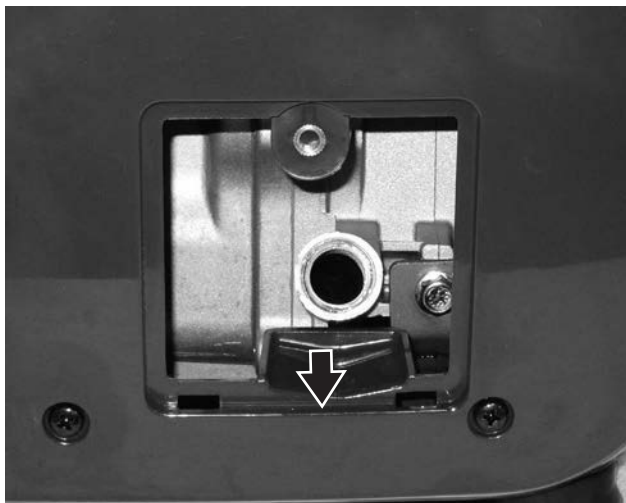

Figure 40 – Draining Engine Oil

7. Allow oil to completely drain.
8. Fill crankcase with oil following the steps outlined in *Adding Engine Oil*

### NOTICE

Never dispose of used engine oil by dumping the oil into a sewer, on the ground, or into groundwater or waterways. Always be environmentally responsible. Follow the guidelines of the EPA or other governmental agencies for proper disposal of hazardous materials. Consult local authorities or reclamation facility.

9. Dispose of used engine oil properly.

## Cleaning the Air Filter

The air filter must be cleaned after every 50 hours of use or 3 months (frequency should be increased if inverter is operated in a dusty environment).

1. Turn off the inverter and let it cool for several minutes if running.
2. Remove the air cleaner access panel to gain access to the air filter.
3. Remove the screw for the air cleaner cover and remove the cover (see Figure 43).



Figure 43 – Air Cleaner Cover

4. Remove the foam element from the air cleaner housing (see Figure 44).



Figure 44 – Foam Element

# MAINTENANCE

5. Wash the foam air filter element by submerging the element in a solution of household detergent soap and warm water. Slowly squeeze the foam to thoroughly clean.

## NOTICE

NEVER twist or tear the foam air filter element during cleaning or drying. Only apply slow but firm squeezing action.

6. Rinse in clean water by submerging the air filter element in fresh water and applying a slow squeezing action.

## NOTICE

Never dispose of soap cleaning solution used to clean the air filter by dumping the solution into a sewer, on the ground, or into groundwater or waterways. Always be environmentally responsible. Follow the guidelines of the EPA or other governmental agencies for proper disposal of hazardous materials. Consult local authorities or reclamation facility.

7. Dispose of used soap cleaning solution properly.
8. Dry the air filter element by again applying a slow firm squeezing action.
9. Return the air filter element to its position in the air cleaner housing.
10. Install the air cleaner cover, making sure the tabs lock into place.
11. Install the air cleaner access panel.

## DRAINING THE FLOAT BOWL

1. Remove the engine service panel to access the float bowl drain.

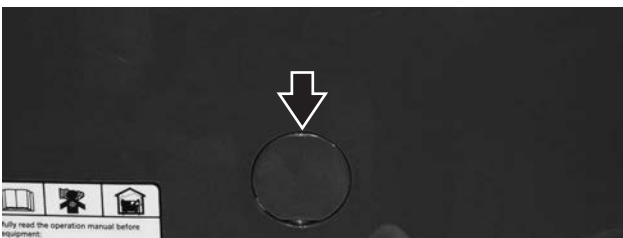

Figure 46 – Engine Service Panel

2. Locate the clear plastic hose from the float that is exiting out the bottom of the inverter, and place a suitable container under it to catch the drained fuel.
3. Loosen the float bowl drain screw until fuel is seen draining from the float bowl (see Figure 47).

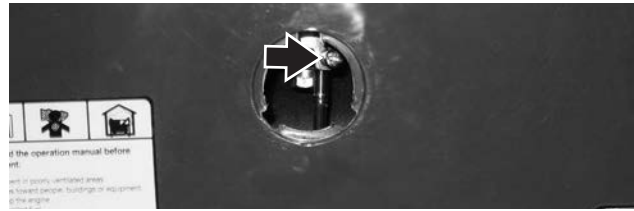

Figure 47 – Float Bowl Drain Screw

4. Allow fuel to drain into the container, and then tighten the float bowl drain screw.

## NOTICE

Never dispose of fuel by dumping fuel into a sewer, on the ground, or into groundwater or waterways. Always be environmentally responsible. Follow the guidelines of the EPA or other governmental agencies for proper disposal of hazardous materials. Consult local authorities or reclamation facility.

5. Install the engine service panel.

## SPARK PLUG MAINTENANCE

The spark plug must be checked and cleaned after every 100 hours of use or 6 months and must be replaced after 300 hours of use or every year.

1. Stop the inverter and let it cool for several minutes if running.
2. Move the inverter to a flat, level surface.
3. Slide the spark plug access cover off the housing (see Figure 48).



Figure 48 – Spark Plug Access Cover

4. Remove the spark plug boot by firmly pulling the plastic spark plug boot handle directly away from the engine (see Figure 49).

# MAINTENANCE

## NOTICE

Never apply any side load or move the spark plug laterally when removing the spark plug. Applying a side load or moving the spark plug laterally may crack and damage the spark plug boot.

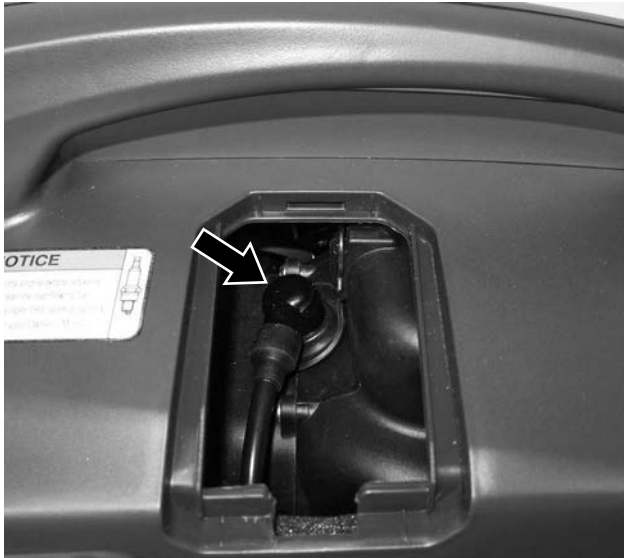

Figure 49 – Removal of Spark Plug Boot

5. Clean area around the spark plug.
6. Using the spark plug socket wrench provided, remove the spark plug from the cylinder head (see Figure 50).



Figure 50 – Removing Spark Plug

7. Place a clean rag over the opening created by the removal of the spark plug to make sure no dirt can get into the combustion chamber.

8. Inspect the spark plug for:
  - Cracked or chipped insulator
  - Excessive wear
  - Spark plug gap of 0.032 in. (0.80 mm) (see Figure 51).

If the spark plug fails any one of the conditions listed above, replace the plug.

## NOTICE

Only use the recommended spark plug (Torch A5RTC or equivalent). See chart below. Using a non-recommended spark plug could result in damage to the engine.

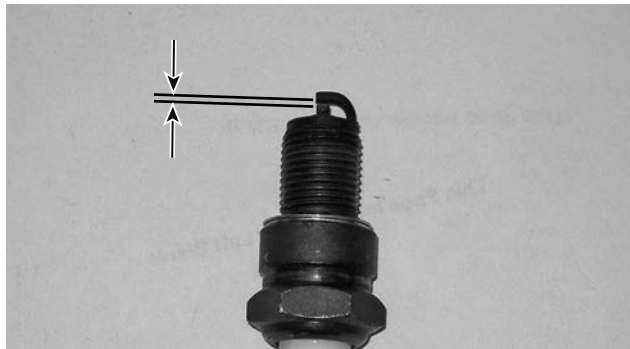

Figure 51 – Spark Plug Gap Requirements

8. Install the spark plug by carefully following the steps outlined below:
  - a - Carefully insert the spark plug back into the cylinder head. Hand-thread the spark plug until it bottoms out.
  - b - Using the spark plug socket wrench provided, turn the spark plug to ensure it is fully seated.
  - c - Replace the spark plug boot, making sure the boot fully engages the spark plug's tip.
  - d - Install the spark plug access cover.

Recommended Spark Plug Replacement:

<b>AutoLite</b>	<b>4194</b>
<b>Denso</b>	<b>6010</b>
<b>NGK</b>	<b>CR4HJB</b>
<b>Torch</b>	<b>A5RTC</b>

# MAINTENANCE

## CLEANING THE SPARK ARRESTOR

Check and clean the spark arrestor after every 100 hours of use or 6 months.

1. Stop the inverter and let it cool for several minutes if running.
2. Move the inverter to a flat, level surface.
3. Remove the four screws holding the muffler cover in place (see *Figure 52*).



*Figure 52 – Muffler Cover*

4. Loosen the clamp holding the spark arrestor onto the muffler (see *Figure 53*).

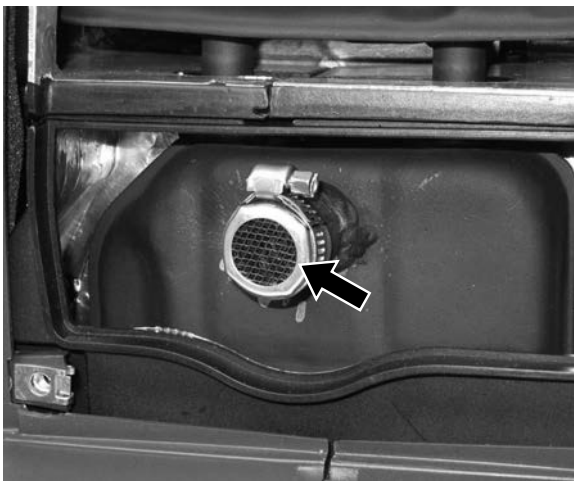

*Figure 53 – Spark Arrestor Clamp*

5. Slide the spark arrestor band clamp off the spark arrestor screen.

6. Pull the spark arrestor screen off the muffler exhaust pipe.
7. Using a wire brush, remove any dirt and debris that may have collected on the spark arrestor screen.
8. If the spark arrestor screen shows signs of wear (rips, tears or large openings in the screen), replace the spark arrestor screen.
9. Install the spark arrestor components in the following order:
  - a - Place spark arrestor screen over the muffler exhaust pipe. Push on the screen until it fully bottoms out.
  - b - Place the spark arrestor band clamp over the screen and tighten with a flathead screwdriver.

## CHECKING AND ADJUSTING VALVE LASH

### CAUTION



Checking and adjusting valve lash must be done when the engine is cold.

1. Remove the rocker arm cover and carefully remove the gasket. If the gasket is torn or damaged, it must be replaced.
2. Remove the spark plug so the engine can be rotated more easily.
3. Rotate the engine to top dead center (TDC) of the compression stroke. Looking through the spark plug hole, the piston should be at the top.
4. Both the rocker arms should be loose at TDC on the compression stroke. If they are not, rotate the engine 360°.



# MAINTENANCE

5. Insert a feeler gauge between the rocker arm and the push rod and check for clearance (see Figure 54). See Table 2 for valve lash specifications.

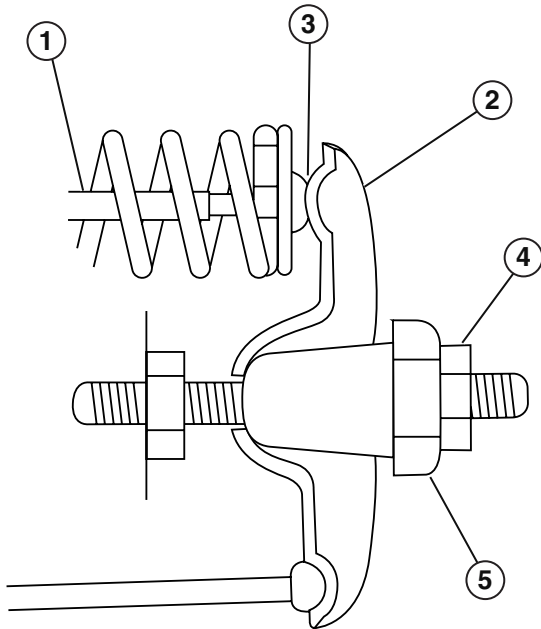

Figure 54

- |                       |                   |
|-----------------------|-------------------|
| 1 - Push Rod          | 4 - Jam Nut       |
| 2 - Rocker Arm        | 5 - Adjusting Nut |
| 3 - Feeler Gauge Area |                   |

Table 2: Standard Valve Lash

Intake	Exhaust
0.0035 – 0.0043 in. (0.09 – 0.11 mm)	0.0043 – 0.0051 in. (0.11 – 0.13 mm)

6. If an adjustment is required, hold the adjusting nut and loosen the jam nut.
7. Turn the adjusting nut to obtain the correct valve lash. When the valve lash is correct, hold the adjusting nut and tighten the jam nut to 106 in-lb (12 N·m).
8. Recheck the valve lash after tightening the jam nut.
9. Perform this procedure for both the intake and exhaust valves.
10. Install the rocker arm cover, gasket and spark plug.

## CLEANING THE INVERTER

It is important to inspect and clean the inverter before every use.

**Clean All Engine Air Inlet and Outlet Ports** – Make sure all engine air inlet and outlet ports are clean of any dirt and debris to ensure the engine does not run hot.

## STORAGE

### WARNING



Never store an inverter with fuel in the tank indoors or in a poorly ventilated area where the fumes can come in contact with an ignition source such as a: 1) pilot light of a stove, water heater, clothes dryer or any other gas appliance; or 2) spark from an electric appliance.

### NOTICE

Gasoline stored for as little as 60 days can go bad, causing gum, varnish and corrosive buildup in fuel lines, fuel passages and the engine. This corrosive buildup restricts the flow of fuel, preventing an engine from starting after a prolonged storage period.

Proper care should be taken to prepare the inverter for any storage.

1. Clean the inverter as outlined in *Cleaning the Inverter*
2. Siphon all gasoline from the fuel tank as best as possible.
3. Start the engine and allow the inverter to run until all the remaining gasoline in the fuel lines and carburetor is consumed and the engine shuts off.
4. Drain any remaining fuel from the float bowl.
5. Change the oil
6. Remove the spark plug and place about 1 tablespoon of oil in the spark plug opening. While placing a clean rag over the spark plug opening, slowly pull the recoil handle to allow the engine to turn over several times. This will distribute the oil and protect the cylinder wall from corroding during storage.
7. Replace the spark plug.
8. Move the inverter to a clean, dry place for storage.

# MAINTENANCE

## Service Parts



Figure 56



# MAINTENANCE

Item	WH#	Description	Qty
2	260005	Reset Breaker	1
3	260014	Efficiency Mode Switch	1
4	260021	Choke Cable	1
5	260039	12-volt DC Power Socket	1
6	260020	Recoil Starter	1
7	260019	Spark Plug Cover (Blue)	1
8	260003	A5RTC (Torch) Spark Plug	1
9	260017	Oil Filling Cover (Blue)	1
10	260015	Oil Filler Plug	1
11	260018	Draining Fuel Cover, Carburetor (Blue)	1
12	260026	Rubber Support Feet	4
13	260016	Air Cleaner Element	1
14	260007	Fuel Tank Cap Assy.	1
15	260028	Fuel Strainer	1
16	260025	Muffler Outer Cover	1
17	260024	Hose Clamp	1
18	260023	Lock Cap, Spark Arrestor Element	1
19	260022	Spark Arrestor Element	1
20	260040	Air Intake Cover	1
21	260043	Fuel Valve	1
22	260044	Engine/Fuel Control Knob	1
23	140083	Carburetor	1
25	260051	Front Housing	1
26	260052	Rear Housing	1
27	260027	Indicator Lights	1

# TROUBLESHOOTING

## TROUBLESHOOTING

### WARNING



**Before attempting to service or troubleshoot the inverter, the owner or service technician must first read the owner's manual and understand and follow all safety instructions. Failure to follow all instructions may result in conditions that can lead to voiding of the EPA certification or product warranty, serious personal injury, property damage or even death.**

PROBLEM	POTENTIAL CAUSE	SOLUTION
Engine is running, but no electrical output.	1. Reset breaker is tripped.	1. Reset the reset breaker
	2. The power cord's plug connector is not fully engaged in the inverter's outlet.	2. Verify plug connector is firmly engaged in the inverter's outlet.
	3. Faulty or defective power cord	3. Replace power cord.
	4. Faulty or defective electrical appliance	4. Try connecting a known good appliance to verify the inverter is producing electrical power.
Engine will not start or remain running while trying to start.	1. Inverter is out of gasoline.	1. Add gasoline to the inverter
	2. Fuel flow is obstructed.	2. Inspect and clean fuel delivery passages.
	3. Unit is overchoked.	3. Move the choke knob halfway between the <b>ON</b> and <b>OFF</b> positions.
	4. Dirty air filter	4. Check and clean the air filter
	5. Low oil level shutdown switch is preventing the unit from starting.	5. Check oil level and add oil if necessary
	6. Spark plug boot is not fully engaged with the spark plug tip.	6. Firmly push down on the spark plug boot to ensure the boot is fully engaged.
	7. Spark plug is faulty.	7. Remove and check the spark plug. Replace if faulty
	8. Dirty/plugged spark arrestor	8. Check and clean the spark arrestor
	9. Stale fuel	9. Drain fuel and replace with fresh fuel.
	10. Fuel system needs priming	10. Prime the fuel system
Inverter suddenly stops running.	1. Inverter is out of fuel.	1. Check fuel level . Add fuel if necessary.
	2. The low oil shutdown switch has stopped the engine.	2. Check oil level and add oil if necessary
	3. Too much load	3. Restart the inverter and reduce the load.
Engine runs erratic; does not hold a steady RPM.	1. Choke was left in the <b>ON</b> position.	1. Move choke to the <b>OFF</b> position.
	2. Dirty air filter	2. Clean the air filter
	3. Applied loads may be cycling on and off	3. As applied loads cycle, changes in engine speed may occur; this is a normal condition.

# MAINTENANCE NOTES

# MAINTENANCE NOTES

# MAINTENANCE NOTES





[WestinghousePortablePower.com](http://WestinghousePortablePower.com)

**Service Hotline: (855) 944-3571**

**777 Manor Park Drive  
Columbus, OH 43228**

™ & © 2016 Westinghouse Electric Corporation  
© 2016 MWE Investments, LLC. All Rights Reserved.

**Version 6.8.17KD**