

This Is A Manual.

Moisture Manager Heavyweight (50 pt)

Moisture Manager Lightweight (22 pt)

BEFORE FIRST USE:

To prevent any internal damage, it is very important to keep refrigeration units (like this one) upright throughout their journey. Please leave it standing upright and outside the box for **24 HOURS** before plugging it in.

TABLE OF CONTENTS

Important Safety Instructions	4-5
Parts Description	6
Operation	7-9
Care & Cleaning	10
Troubleshooting	10
Warranty	11
Warning	11
Drop Us A Line	11

IMPORTANT SAFETY INSTRUCTIONS



IMPORTANT NOTICE FOR FIRST TIME USE

PLEASE NOTE:

This dehumidifier defaults to **CONTINUOUS MODE**, which disables use of the **LEFT/RIGHT** buttons. To regain use of the buttons, turn off **CONTINUOUS MODE**.

TURN ON
DEHUMIDIFIER ▶

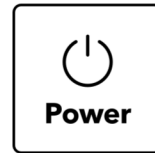

TURN OFF
CONTINUOUS MODE ▶

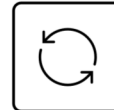

Cont.

BEGIN USING
LEFT/RIGHT BUTTONS ▶

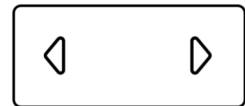

To prevent injury to the user or other people and property damage, the following instructions must be followed when using the Dehumidifier. Incorrect operation due to ignoring of instructions may cause harm or damage.

1. Do not exceed the rating of the power outlet or connection device.
2. Do not operate or turn off the dehumidifier by plugging in or unplugging the device. Use the control panel instead.
3. Do not use if the power cord is broken or damaged.
4. Do not modify the power cord length or share the outlet with other appliances.
5. Do not touch the plug with wet hands.
6. Do not install the dehumidifier in a location that may be exposed to combustible gas.
7. Do not place the dehumidifier near a heat source.
8. Disconnect the power if strange sounds, smell, or smoke comes from the dehumidifier.
9. You should never try to take apart or repair the dehumidifier by yourself.
10. Make sure to turn off and unplug the dehumidifier before cleaning.
11. Do not use the dehumidifier near flammable gas or combustibles, such as gasoline, benzene, thinner, etc.
12. Do not drink or use the water drained from the dehumidifier.
13. Do not take the water bucket out while the dehumidifier is working.
14. Do not use the dehumidifier in small spaces.
15. Do not place the dehumidifier in places where it may be splashed by water.
16. Place the dehumidifier on a level, sturdy section of the floor.
17. Do not cover the intake or exhaust openings with cloths or towels.
18. Care should be taken when using the dehumidifier in a room with the following persons: infants, children, the elderly and people not sensitive to humidity.
19. Do not use in areas where chemicals are handled.
20. Never insert your finger or other foreign objects into grills or openings. Take special care to warn children of these dangers.
21. Do not place a heavy object on the power cord and make sure that the cord is not compressed.
22. Do not climb on or sit on the dehumidifier.
23. If water enters the dehumidifier, turn the dehumidifier off and disconnect the power, contact Vremi Customer Service at 646-490-9904 to avoid a hazard.
24. Do not place flower vases or other water containers on top of the dehumidifier.

SAVE THESE INSTRUCTIONS

For Household Use Only

Important Safety Instructions

ELECTRICAL INFORMATION

- The Vremi nameplate is located on the rear panel of the dehumidifier and contains electrical and other technical data specific to this dehumidifier.

- Be sure the dehumidifier is properly grounded. To minimize shock and fire hazards, proper grounding is important. This power cord is equipped with a three-prong grounding plug for protection against shock hazards.

- Your dehumidifier must be used in a properly grounded wall socket. If your wall socket is not adequately grounded or protected by a time delay fuse or circuit breaker, have a qualified electrician install the proper socket.

- Avoid fire hazard or electric shock. Do not use an extension cord or an adapter plug. Do not remove any prong from the power cord.

- This dehumidifier can be used by children 8 years or older and people with reduced physical, sensory, or mental capabilities. Supervision and use of instructions are required for those with lack of experience and knowledge concerning the dehumidifier. Cleaning and user maintenance shall not be done by children without supervision.

- If the supply cord is damaged, it must be replaced by Vremi. Please contact Vremi Customer Service at 646-490-9904 for a replacement.

- Prior to cleaning or other maintenance, the dehumidifier must be disconnected from the supply mains.

- Do not install the dehumidifier in a location that may be exposed to combustible gas.

- If combustible gas accumulates around the dehumidifier, it may cause fire.

- If this dehumidifier is knocked over during use, turn off the dehumidifier and unplug it from the main power supply immediately. Visually inspect the dehumidifier to ensure this is no damage. If you suspect this dehumidifier has been damaged, contact Vremi Customer Service at 646-490-9904 for repair or a replacement.

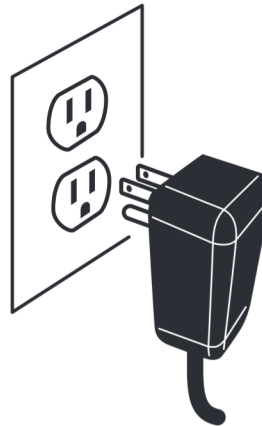

- In a thunderstorm, the power must be cut off to avoid damage to the dehumidifier due to lightning.

- Do not run cord under carpeting. Do not cover cord with throw rugs, runners, or similar coverings. Do not route cord under furniture or other appliances. Arrange cord away from traffic area and where it will not be tripped over.

- Do not operate dehumidifier with a damaged cord or plug. Please contact Vremi Customer Service at 646-490-9904.

- To reduce the risk of fire or electric shock, do not use this dehumidifier with any solid-state speed control device.

- The dehumidifier shall be installed in accordance with national wiring regulations.

- Contact Vremi Customer Service at 646-490-9904 for repair or maintenance of this dehumidifier.

Parts Description

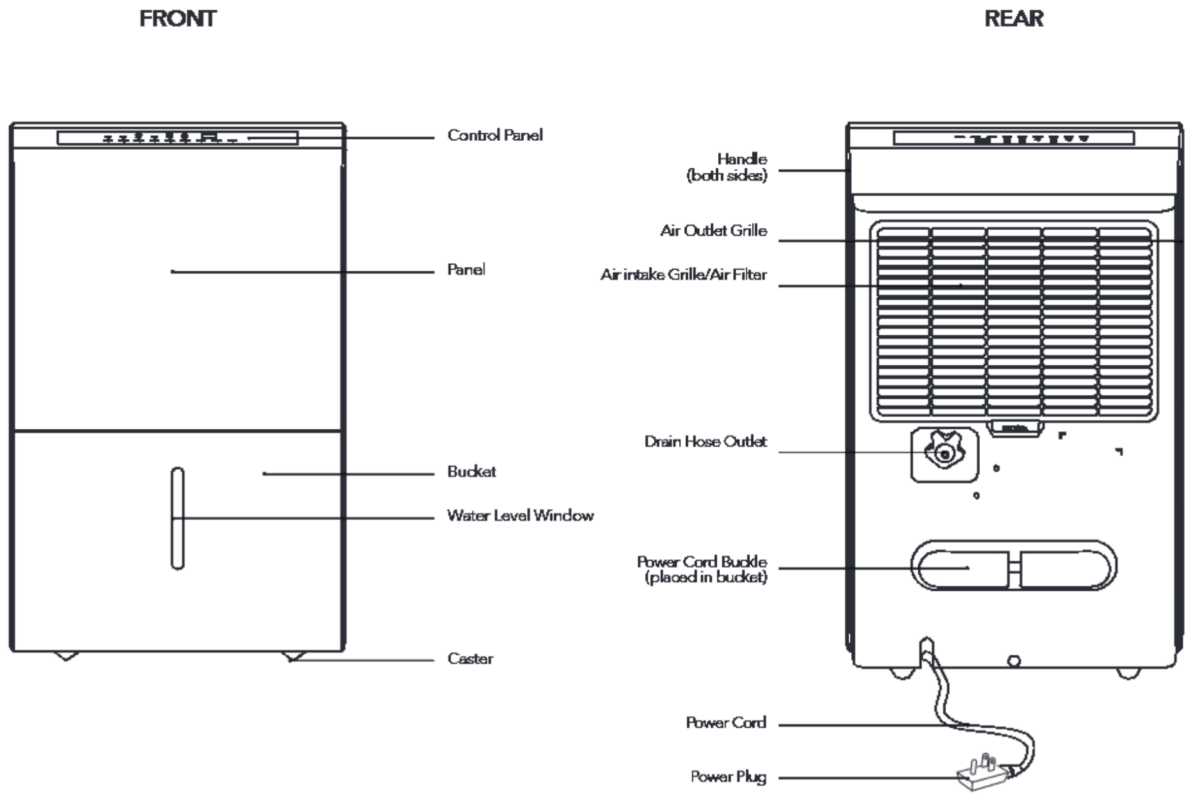

ACCESSORIES

(placed in the bucket of the dehumidifier)



Pump Drain Hose (1pc)
(only for the dehumidifier with pump feature)



Power Cord Buckle (1pc)



Threaded Female End (1pc)
(on some models)

Operation

PLACE CORRECTLY

- This unit may have been tilted or placed upside down during shipping. To ensure this device works properly, please ensure this unit is upright for at least 24 hours before initial use.
 - This dehumidifier is designed to operate with a working environment between 41°F (5°C) and 90°F (32°C).
- Casters (Installed at four points on the bottom of the dehumidifier)
- Do not force casters to move over carpet, or move the dehumidifier with water in the bucket.
(The dehumidifier may tip over and spill water.)

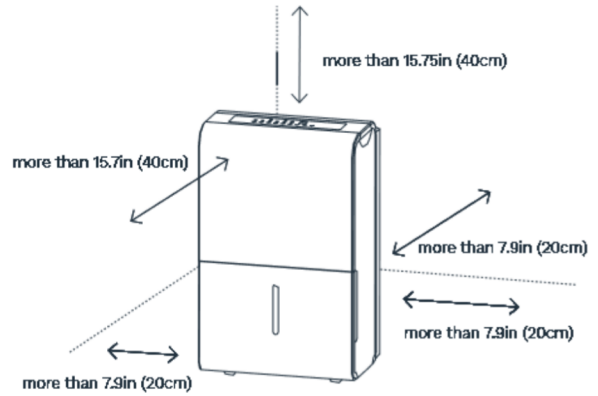

NOTE: Some models do not come with casters.

SMART FUNCTIONS

- Auto Shut Off

When the bucket is full and/or the humidity setting is reached, the dehumidifier will be shut off automatically.

- Wait 3 minutes before resuming operation

To avoid any damage to the dehumidifier, the dehumidifier will not start operation following a complete cycle until after three (3) minutes. Operation will automatically start after three (3) minutes.

- Defrost

When frost builds up on the evaporator coils, the compressor will cycle off and the fan will continue to run until the frost disappears.

- Auto Restart

If the dehumidifier shuts off unexpectedly, due to the power being cut, the dehumidifier will restart with the previous function setting automatically when the power resumes.

NOTE:

All illustrations in this manual are for explanation purposes only. Your dehumidifier may be slightly different. Contact Vremi Customer Service at 646-490-9904 for details.

CONTROL PANEL

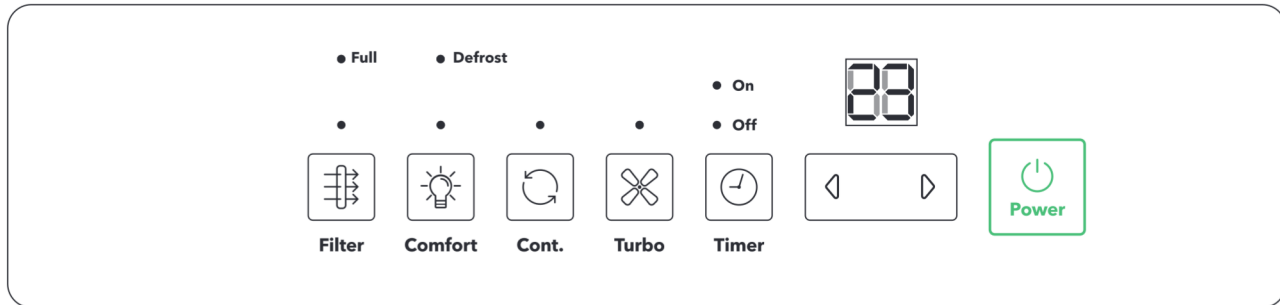

Filter

FILTER button

The check filter feature is a reminder to clean the Air Filter for more efficient operation. The Filter light (clean filter light) will flash after 250 hours of operation. To reset after cleaning the filter, press the filter button and the light will go off.



Cont.

CONTINUOUS button

Press to activate the Continuous dehumidifying operation.



Comfort

COMFORT button

Press this button to turn the comfort function on/off. Under this mode, the humidity cannot be adjusted manually but will be preset to a recommended comfortable and healthy level based on the ambient temperature. The level will be controlled as per below table:

Ambient Temperature	<65 °F	65 -77 °F	>77 °F
Relative Humidity	55 %	50 %	45 %



Turbo

TURBO button

Control the fan speed. Press to select either High or Normal fan speed. Set the fan control to High for maximum moisture removal. When the humidity has been reduced and quiet operation is preferred, set the fan control to Normal.



LEFT / RIGHT buttons

NOTE: When the dehumidifier is first turned on, it will go on Continuous mode by default. This will disable use of the LEFT/RIGHT buttons. Make sure to turn off Continuous mode to regain function in these buttons.

Humidity Set Control buttons

- The humidity level can be set within a range of 35%RH (Relative Humidity) to 85%RH (Relative Humidity) in 5% increments.

- For drier air, press the button and set to a lower percent value (%).
- For damper air, press the button and set a higher percent value (%).

Timer Set Control buttons

- Press to initiate the Auto start and Auto stop feature, in conjunction with the and buttons.

Indicator Lights

- ONTimer ON light
- OFFTimer OFF light
- FULLThe water tank is full and should be emptied
- DEFROSTThe appliance is on Defrost mode



Power

POWER button

Press to turn the dehumidifier on and off.



Timer

TIMER button

Press to initiate the Auto start and Auto stop feature, in conjunction with the and buttons.

- When the dehumidifier is on, first press the Timer button. The Timer Off indicator light will illuminate. It indicates the Auto Stop program is initiated. Press it again and the Time On indicator light will illuminate. It indicates the Auto Start is initiated.
- When the dehumidifier is off, first press the Timer button. The TIMER ON indicator light illuminates. It indicates the Auto Start program is initiated. Press it again and the Time Off indicator light illuminates. It indicates the Auto Stop is initiated.
- Press or hold the LEFT or RIGHT buttons to change the Auto time by 0.5 hour increments, up to 10 hours, then at 1 hour increments up to 24 hours. The control will count down the time remaining until start.
- The selected time will register in 5 seconds and the system will automatically revert back to display the previous humidity setting.
- When the Auto start & Auto stop times are set, within the same program sequence, TIMER ON and OFF indicator lights illuminate identifying both ON and OFF times are now programmed.
- Turning the dehumidifier ON or OFF at any time or adjusting the timer setting to 0.0 will cancel the Auto Start/Stop function.
- When LED display window displays the code of P2, the Auto Start/Stop function will also be canceled.

Operation

CONTROL PANEL (CONT.)

% LED display

The LED display shows the set % humidity level from 35% to 85% or auto start/stop time (0~24) setting, then shows the actual ($\pm 5\%$ accuracy) room % humidity level in a range of 30% RH (Relative Humidity) to 90% RH (Relative Humidity).

Error Codes:

AS - Humidity sensor error;

ES - Temperature sensor error;

Protection Codes:

P2 - Bucket is full or bucket is not in right position.

Empty the bucket and replace it in the right position.

P2 - Bucket is full. Empty the bucket.

Note: When one of the above malfunctions occurs, turn off the dehumidifier and check for any obstructions. Restart the dehumidifier, if the malfunction is still present, turn off the dehumidifier and unplug the power cord. Contact Vremi Customer Service at 646-490-9904 for repair and/or replacement.

REMOVING THE COLLECTED WATER

There are two ways to remove collected water:

1. Use the bucket

When the bucket is full, remove the bucket and empty it.

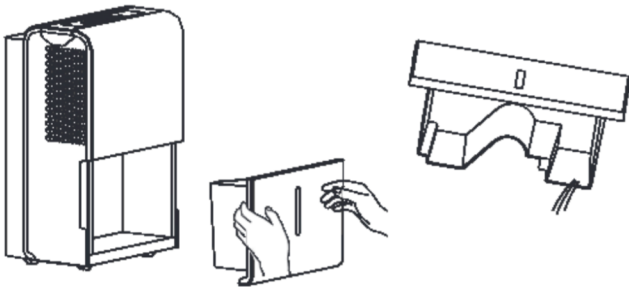

Note: Do not use this operation when the outdoor temperature is equal to or less than 32°F (0°C), otherwise the water will freeze, causing the water hose to block up and the dehumidifier may be damaged.

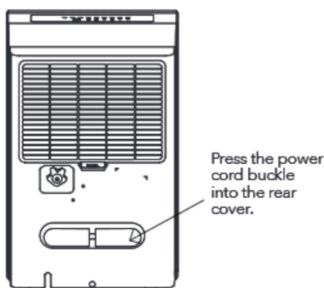

2. Continuous draining

Water can be automatically be emptied into a floor drain by attaching the dehumidifier to a water hose with a female threaded end. (NOTE: On some models, the female threaded end is not included)

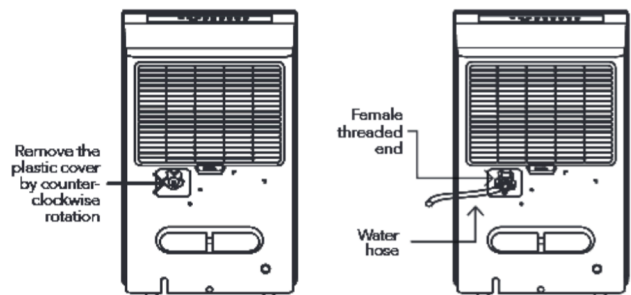

Note:

- Make sure the connection is tight and there is no leaking.
- Lead the water hose to the floor drain or a suitable drainage facility. The drainage facility should be lower than the drain outlet of the dehumidifier.
- Be sure to run the water hose sloping downward to let the water flow out smoothly.
- When the continuous drain feature is not being used, remove the drain hose from the outlet.

Care & Cleaning

CARE AND CLEANING OF THE DEHUMIDIFIER

WARNING: Turn the dehumidifier off and remove the plug from the wall outlet before cleaning.

1. Clean the bucket

Clean the bucket with water every two (2) weeks.

2. Clean the air filter

Clean the filter with potable water at least once every 30 days.

3. Storing the dehumidifier

When not using the dehumidifier for long time periods:

- After turning off the dehumidifier, wait one day before emptying the bucket.
- Clean the main dehumidifier, bucket and air filter.
- Wrap the cord and bundle it with the band.
- Cover the dehumidifier with a plastic bag.
- Store the dehumidifier upright in a dry, well-ventilated place.

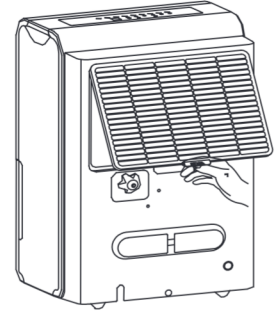

CAUTION: DO NOT operate the dehumidifier without a filter because dirt and lint will clog it and reduce performance.

Troubleshooting

Before calling Vremi customer service, review this list. It may save you time and expense. This list includes the most common occurrences that are not the result of defective workmanship or materials in this dehumidifier.

PROBLEM	CAUSE
Dehumidifier does not start	<ul style="list-style-type: none"> - Make sure the dehumidifier's plug is inserted completely into the outlet. - Check the house fuse/circuit breaker box. - Dehumidifier has reached its preset level or bucket is full. - Bucket is not in the proper position.
Dehumidifier does not dry the air as it should	<ul style="list-style-type: none"> - Did not allow enough time to remove the moisture. - Make sure there are no curtains, blinds or furniture blocking the front or back of the dehumidifier. - The humidity selector may not be set low enough. - Check that all doors, windows and other openings are securely closed. - Room temperature is too low, below 41°F (5°C). - There is a kerosene heater or something giving off water vapor in the room.
The dehumidifier makes a loud noise when operating	<ul style="list-style-type: none"> - The air filter is clogged. - The dehumidifier is tilted instead of upright as it should be. - The floor surface is not level.
Frost appears on the coils	<ul style="list-style-type: none"> - This is normal. The dehumidifier has a Defrost feature.
Water on floor	<ul style="list-style-type: none"> - Hose to connector or hose connection may be loose. - Intended to use the bucket to collect water, but the back drain plug is removed.
Water does not drain from the hose	<ul style="list-style-type: none"> - Hoses more than 5 feet long may not drain properly. It is recommended to keep the hose as short as possible for proper draining. The hose must be placed lower than the bottom of the dehumidifier, and be kept flat and smooth without kinks.

Please contact Vremi Customer Service at 646-490-9904 if this dehumidifier does not operate properly and the solutions above are not helpful.

Warranty

Vremi offers a 12-month warranty on all of our products purchased new and unused from Vremi LLC or an authorized reseller, with an original proof of purchase and where a defect has arisen, wholly or substantially, as a result of faulty manufacturing, parts or workmanship during the Warranty Period. The warranty does not apply where damage is caused by other factors, including without limitation: (a) normal wear and tear; (b) abuse, mishandling, accident or failure to follow operating instructions; (c) exposure to liquid or infiltration of foreign particles; (d) servicing or modification of the product other than by Vremi. These are our general terms for the warranty service, but we always urge our customers to reach out to us with any issue, regardless of warranty terms. If you experience an issue with a Vremi product, please contact us at support@vremi.com or (646) 490-9904, and we will do our best to resolve it for you.

Warning

This manual is to be used with all items with the model numbers

VRM010637
VRM010184

WARNING: Keep all plastic bags away from children.

State of California Proposition 65 Warnings:

WARNING: THIS PRODUCT COULD CONTAIN ONE OR MORE CHEMICALS WHICH ARE KNOWN TO THE STATE OF CALIFORNIA TO CAUSE CANCER, BIRTH DEFECTS OR OTHER REPRODUCTIVE HARM.

Manufacturer, distributor, importer and seller are not liable for ANY damage caused by improper use, storage, care or failure to follow warnings associated with this product.

Drop Us A Line

 CHAT WITH US

vremi.com/chat

 CALL US

(646) - 490 - 9904

 EMAIL US

support@vremi.com



vremi.com